



**forsterunico<sup>®</sup>**

CORREDERA ELEVABLE



# forsterunico®

## CORREDERA ELEVABLE

Sistema completamente en acero / acero inox

Carga máxima 400 Kg (también motorizado) según la norma EN 14351-1

$UF \geq 1,9 [W/(m^2 \cdot K)]^2$  según la norma EN 10077-2

Permeabilidad al aire según la norma EN 12207: Clase 4

Protección a lluvias torrenciales según la norma EN 12208: Clase 8A (450 pa)

Resistencia a la carga de viento según la norma EN 12210: Clase 4I

Aislamiento acústico según la norma EN 140-1: 33/47 dB

Resistencia de maniobra del mecanismo según la norma EN 12046-1: Clase 1

Rigidez mecánica / torsión conforme EN 14608: Clase 5

### Posibles tipos de apertura

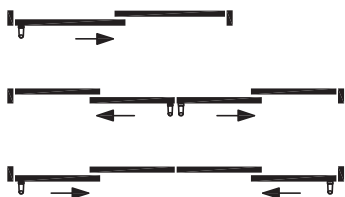



CORREDERA ELEVABLE

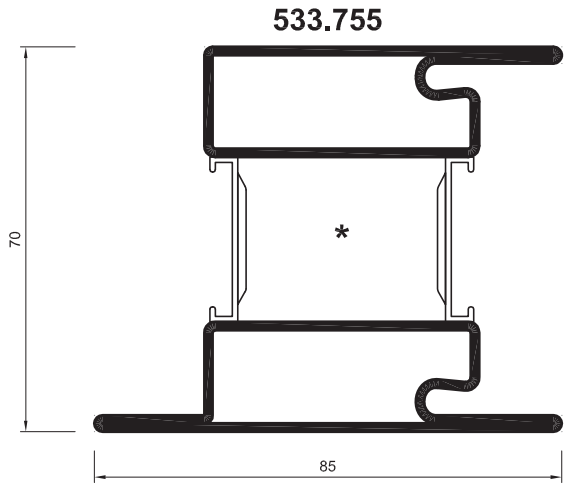
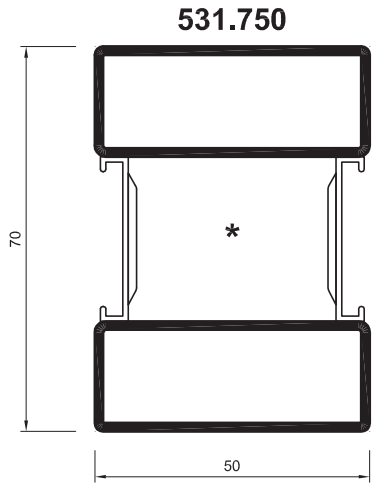
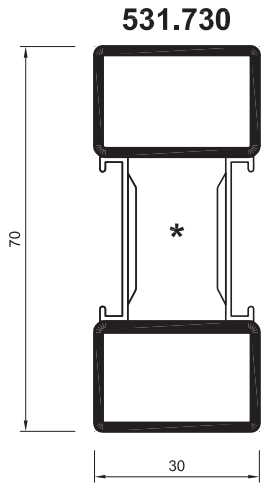

**983.104 Acero sendzimir**  
**983.105 Acero inox**

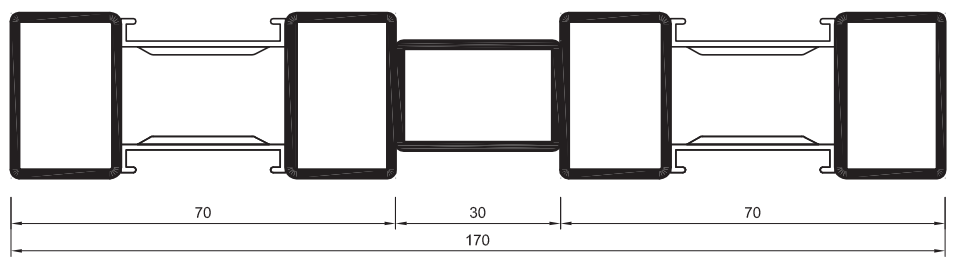

\* disponible en acero sendzimir y acero inox



# Vistas y secciones

Vista interior

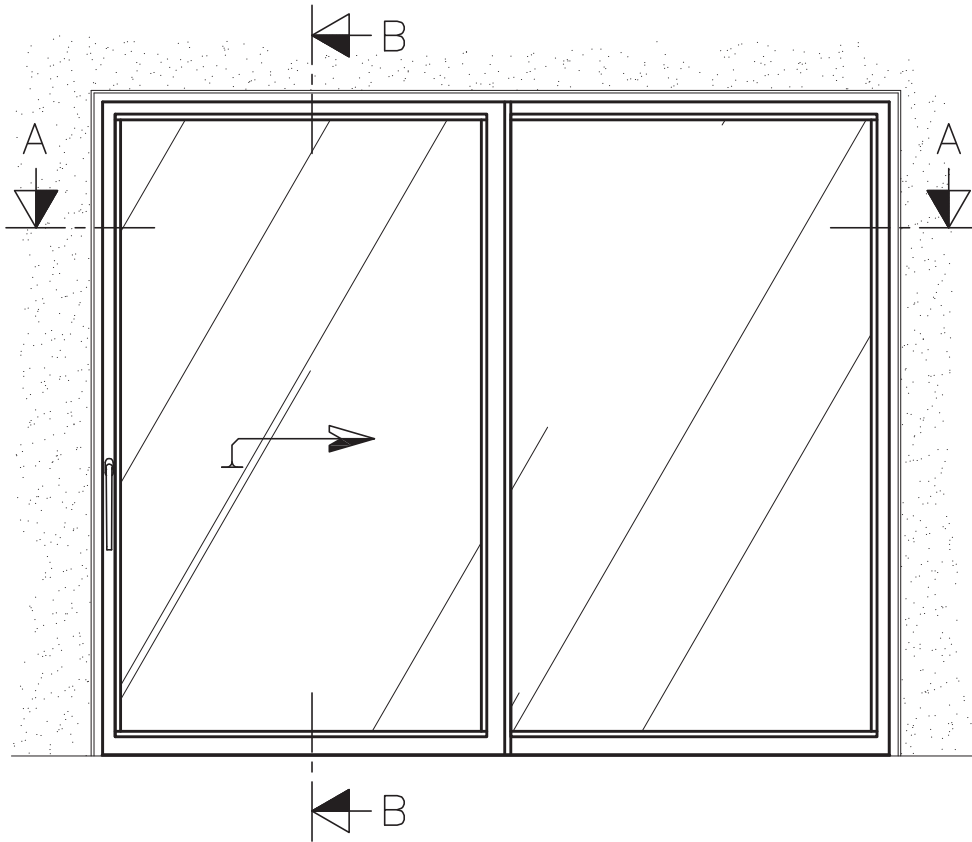

Secc. A-A

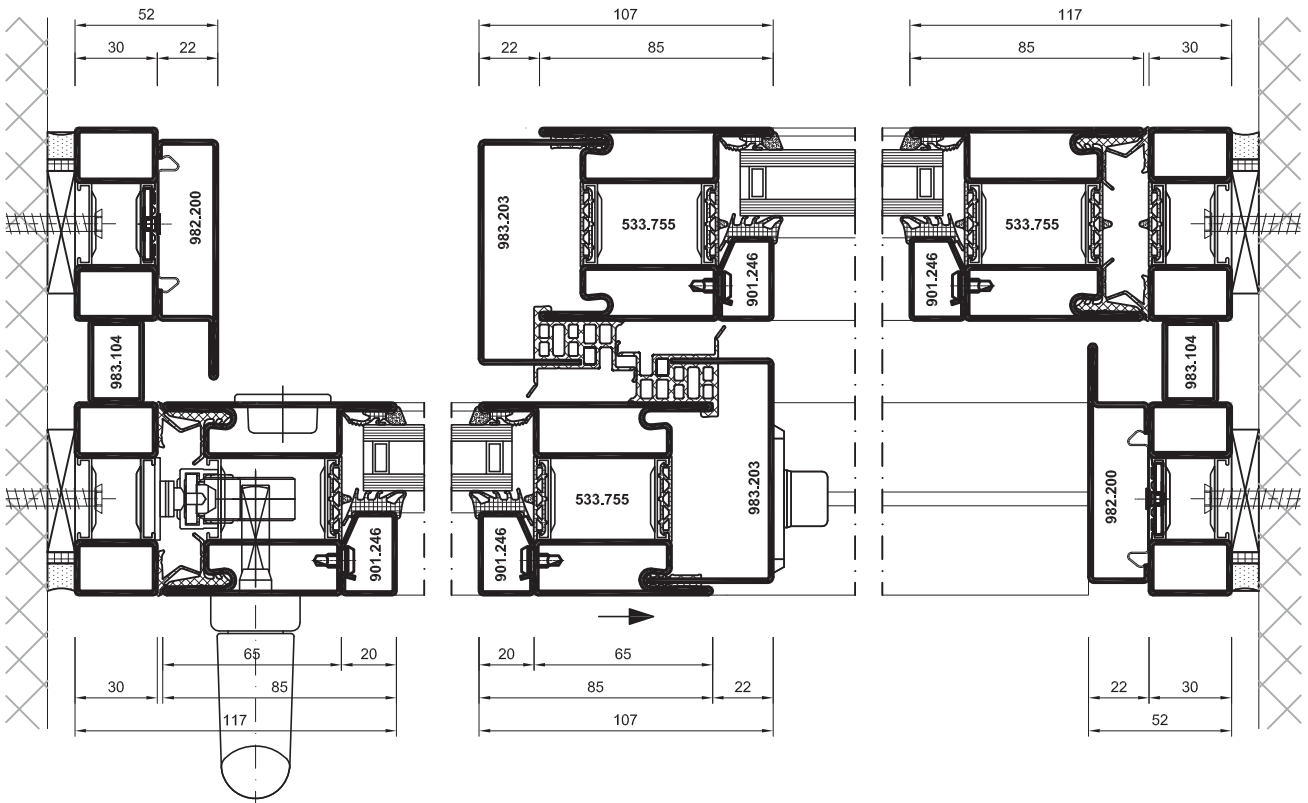



Secc. B-B

- corredera elevable -

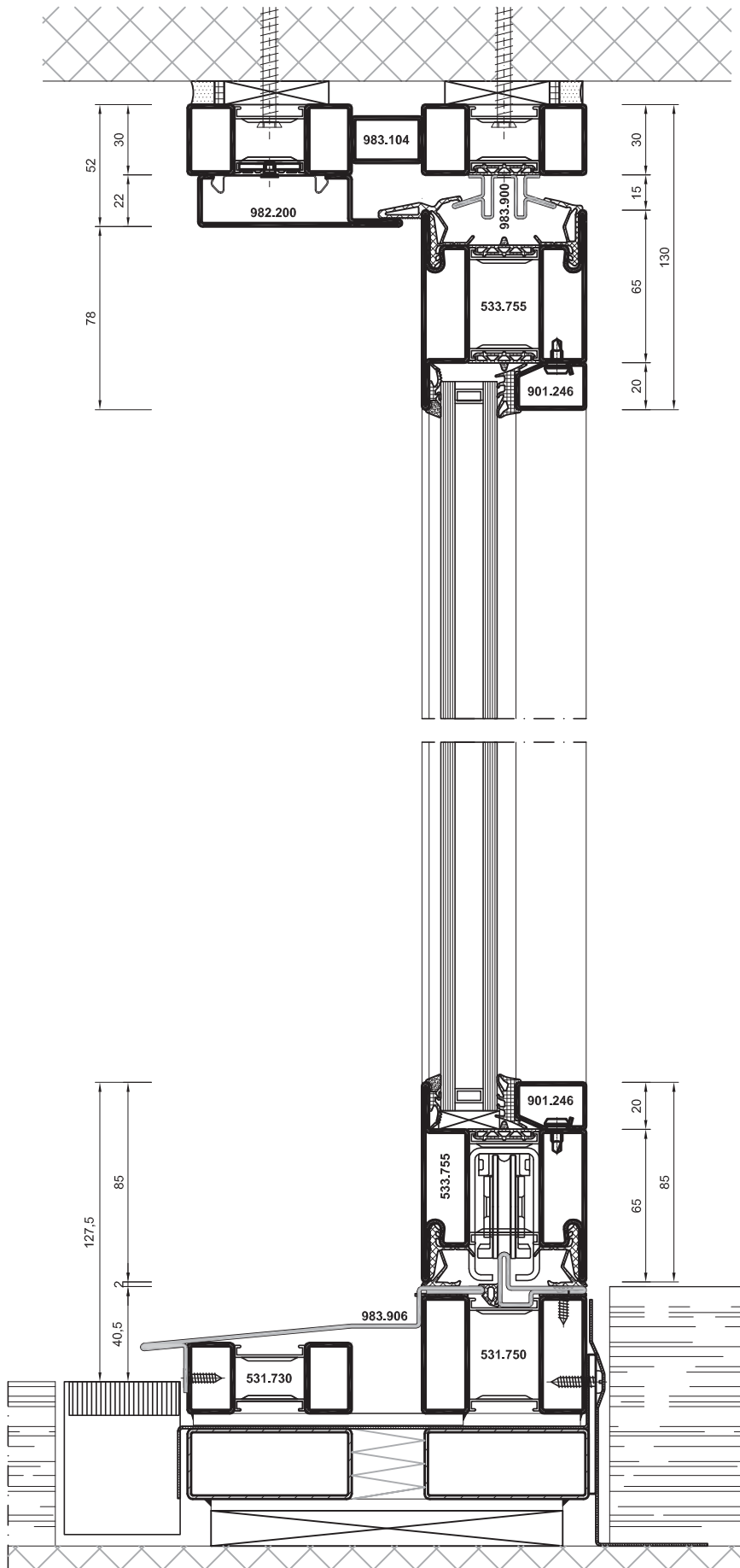



## Junquillos en acero sendzimir

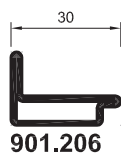
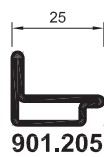
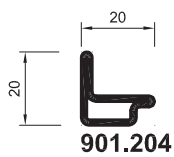
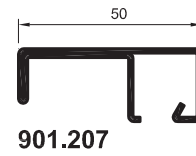
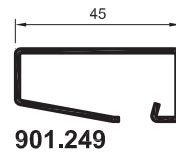
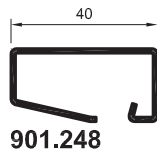
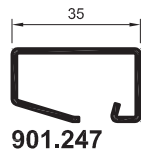
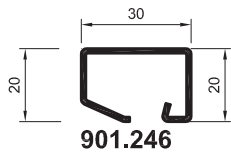
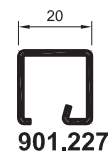
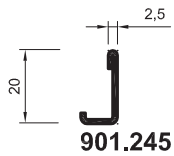

## Junquillos en aluminio

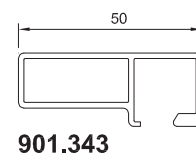
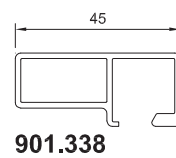
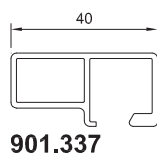
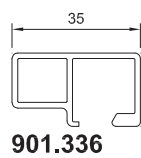
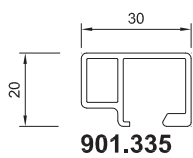
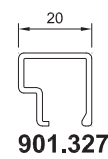
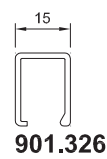
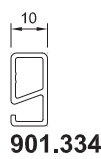
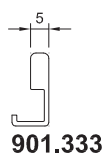
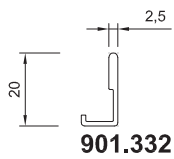

## Junquillos en acero inox

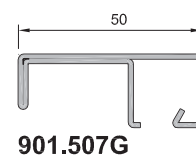
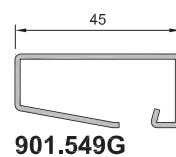
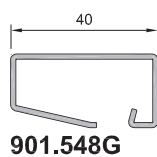
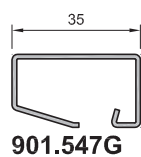
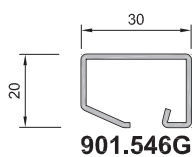
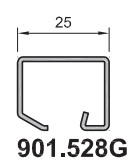
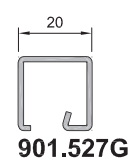
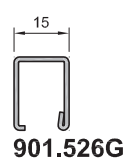
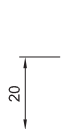



# Juntas



985.306



985.307

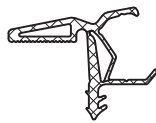

985.308



985.309

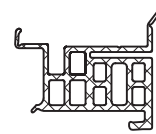

985.310

# Complementos

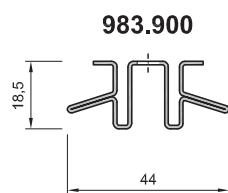

983.900

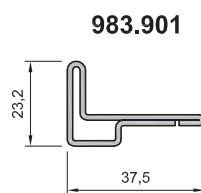

983.901

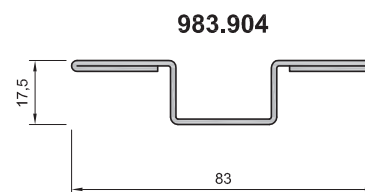

983.904

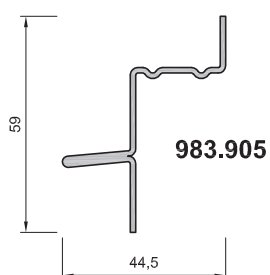

983.905

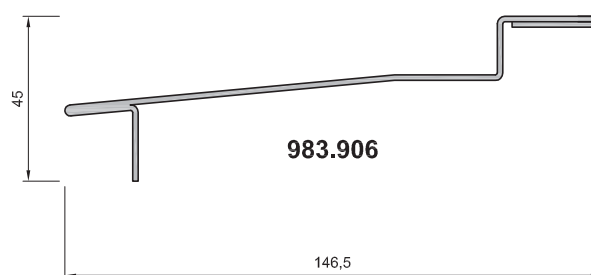

983.906

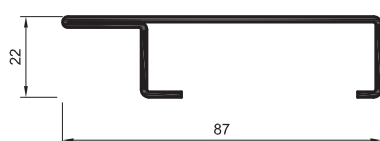

982.200 Acero  
982.500 Acero inox

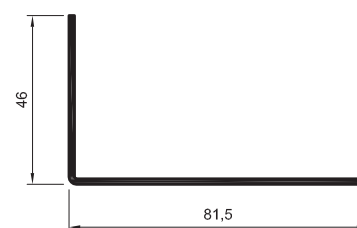

983.203 Acero  
983.907 Acero inox